



E-mail: distributor@hyggeraquarium.com

Website: www.hyggeraquarium.com



HG155 USER MANUAL

hygger Round Ceramic Aquarium Heater

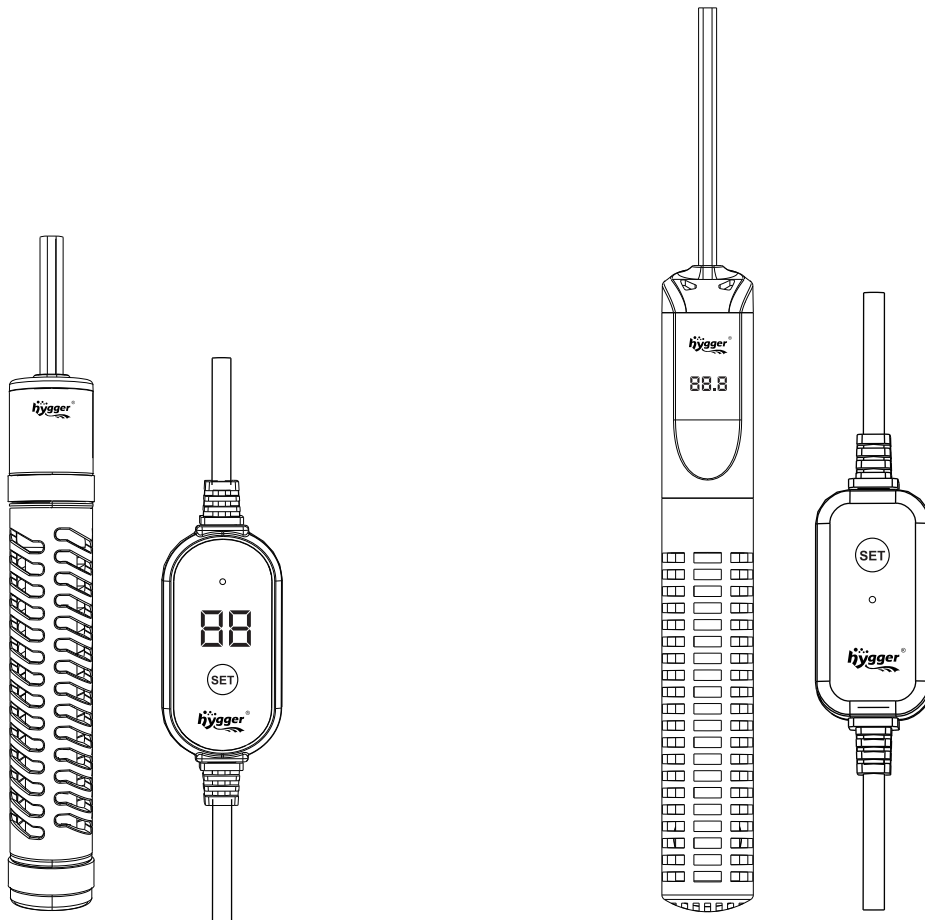

HG155
15W/50W

HG155
100W/200W/300W/500W

The hygger Round Ceramic Aquarium Heater is suitable for aquariums ranging from 1 to 120 gallons and is versatile for use in various environments such as desktops, offices, and homes.



CAUTION

1) Place the heater fully submersible when it's on duty. Unplug the heater and wait for 15 minutes before changing the water or removing it.

2) Please make sure there is enough water flow and water circulation in your fish tank when using the heater.

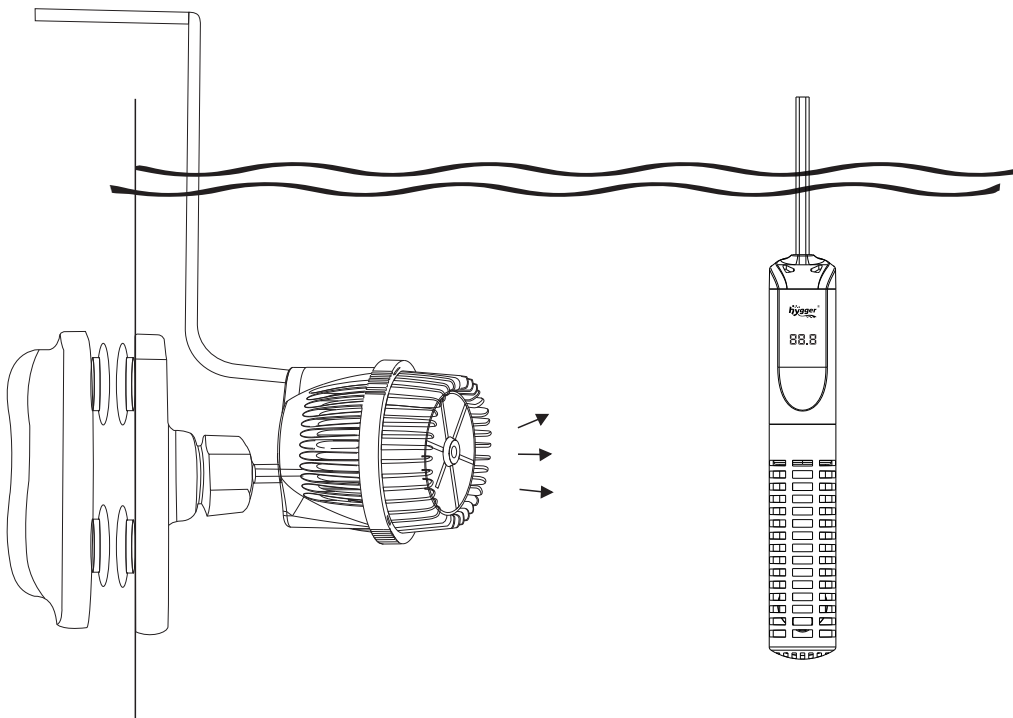

3) Please do not bury the heating rod or use it near the sand.

1. Product Features

Enhanced Durability Ceramic Aquarium Heater: This heater, crafted from ceramic and high-temperature resistant nichrome wire, heats water more quickly, offers increased robustness, and superior safety features. Its casing, constructed from high-temperature resistant ABS material, safe guards both you and your fish from scalds.

Protection Against High Temperatures And Low Water Levels: When below the minimum water level, the heating rod will stop heating and display the error code "E01", and will not resume working until the heating rod is fully submerged in water. When the temperature is above 96°F(36°C), the heating rod will stop working and display the error code "HH", and the heating rod will not resume normal operation until the aquarium temperature is below 96°F(36°C).

Featuring A Digital Display and A Single-button Controller: it offers an adjustable temperature range of 64-95°F(18-35°C), accurate to within 1°F. The heater displays the current water temperature, enabling real-time monitoring of your aquarium's conditions. Easily view and adjust the temperature with the user-friendly single-button controller by pressing the 'SET' button.

Complete Accessories and Warranty: This model of aquarium heater includes all the necessary accessories, such as 1 aquarium heater, 1 controller, and 3 suction cups. Starting from your purchase date, we offer a 2-year warranty. If you encounter any issues with the heater, feel free to reach out anytime for assistance, and we will strive to resolve them.

2. PRODUCT SPECIFICATIONS

Model	HG155 -15W	HG155 -50W
Volt/Freq	US standard: AC110-120V/60Hz EU/UK/AU standard: AC220-240V/50Hz	
Cord length	1.5m+1.5m (4.9ft+4.9ft)	
Applicable tank size	1-5Gal (3.8-19L)	3-10Gal (11-38L)
Temp accuracy	1°F(1°C)	
Temp tolerance range	±1°F(±1°C)	
Heater rod dimension	20*20*95MM	
Control range	64-95°F (18-35°C)	

Model	HG155 -100W	HG155 -200W
Volt/Freq	US standard: AC110-120V/60Hz EU/UK/AU standard: AC220-240V/50Hz	
Cord length	1.5m+1.5m (4.9ft+4.9ft)	
Applicable tank size	5-20Gal (19-76L)	10-40Gal (37-151L)
Temp accuracy	0.1°F(0.1°C)	
Temp tolerance range	±1°F(±1°C)	
Heater rod dimension	35*38*195MM	
Control range	64-95°F (18-35°C)	

Model	HG155 -300W	HG155 -500W
Volt/Freq	US standard: AC110-120V/60Hz EU/UK/AU standard: AC220-240V/50Hz	
Cord length	1.5m+1.5m (4.9ft+4.9ft)	
Applicable tank size	25-80Gal (94-300L)	60-120Gal (220-454L)
Temp accuracy	0.1°F(0.1°C)	
Temp tolerance range	±1°F(±1°C)	
Heater rod dimension	35*38*230MM	35*38*275MM
Control range	64-95°F (18-35°C)	

3. INSTRUCTIONS

1) Securely attach the heater in the aquarium using the provided suction cups, following the methods depicted in figures 1 and 2. Do not expose the heater above the water surface as shown in figure 3, nor should it be inverted at the water surface as depicted in figure 4, or buried in the aquarium gravel as in figure 5.

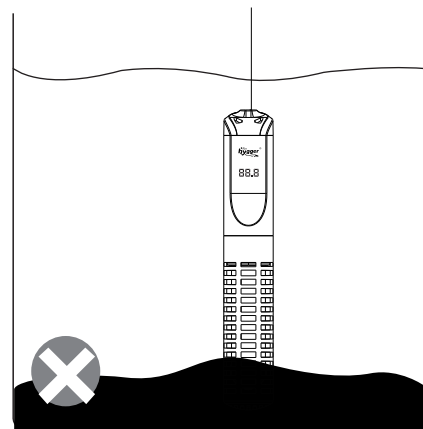
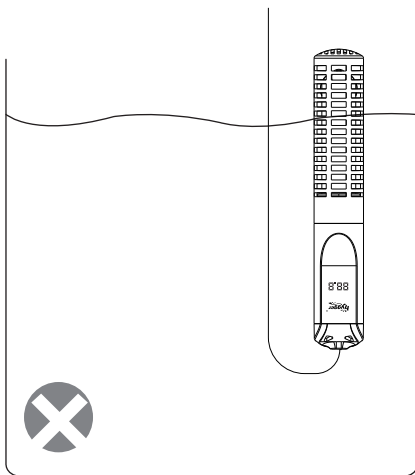
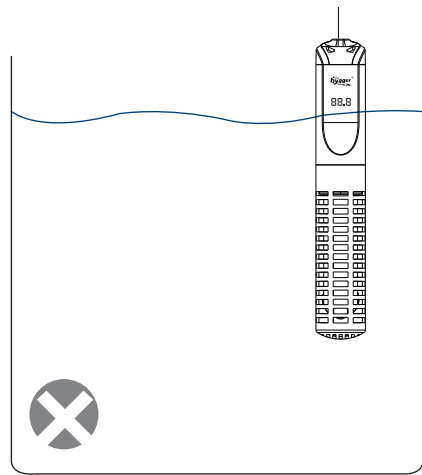
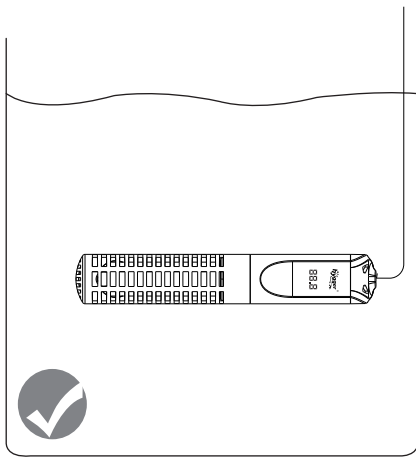
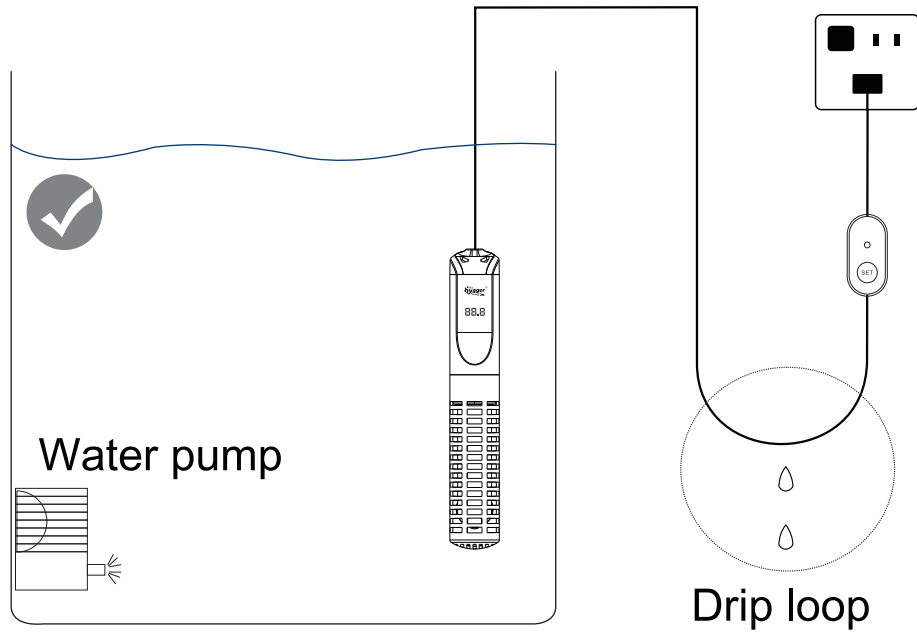

2) To set the temperature, connect the power and press the "SET" button on the controller. Press the 'SET' button once; the digital display will flash, indicating the heater is now in setting mode. Continue pressing the 'SET' button to increase the temperature, with each press raising it by 1°F. Adjust within the range of 64-95°F (18-35°C) until you reach your desired setting. After setting the desired temperature, the display will stop flashing to confirm the setting.

3) Under normal conditions, the digital temperature display shows the current water temperature of the aquarium. If the set temperature is higher than the aquarium's water temperature, the red heating indicator lights up indicates that the heater is heating. Conversely, if the actual water temperature meets or above the set temperature, the heating indicator light goes off, signaling that the heater is not heating. It is necessary to run the water pump during the operation of the heater to ensure proper water circulation in the aquarium.

4. MAINTENANCE

- Unplug or switch off all appliances in the aquarium before carrying out maintenance.
- Do not use detergents or other chemical cleaners.
- To clean the heater, unplug it first and then leave the heater in the tank for 15 minutes and remove it from the tank. Wash the heater in clean water.
- When reinstalling the heater, select your desired location and position the heater below the water.
- This appliance has no parts that can be repaired by users.
- For indoor use only, not in the bathroom.

How to clean the heater correctly:

Begin by soaking the heater in citric acid or vinegar to dissolve any scale, then thoroughly rinse it with clean water.

5. TROUBLESHOOTING

Fault Codes	Explanations	Solutions
Low water level, display flashing "E01"	Heater low-water protection	Add water to fully submerge the heater
"E01" flashing while fully submerged	Heater software error	Contact customer service to reprogram the heater
Display flashing "E02"	Internal component malfunction	Contact customer service for assistance
Display flashing "HH"	Water temperature exceeds 95°F(35°C)	Reduce the temperature to below 95°F(35°C) to resume operation
If the actual water temperature does not meet the heater's set temperature	Poor water flow, uneven temperature	Turn on the water pump to improve water circulation
	If the aquarium's water volume is too large or the ambient temperature is too low.	Consider adding more heaters or using a higher wattage heater

6. WARNING

To avoid possible electric shock, do not immerse the switch in the water. If the switch falls into the water or becomes wet, do not touch it until you have unplugged it. Basic safety precautions that should be observed are as follows:

1. Read and follow this user manual strictly.

2. **DANGER-** To avoid possible electric shock, special care should be taken since water is employed in the use of aquarium equipment. For each of the following situations, do not attempt to repair yourself. Instead, return the heater to an authorized service facility for maintenance or discard it.

A. If the heater shows any sign of abnormal working or, unplug the power and remove the heater from the water after 15 minutes.

B. Carefully examine the heater after installation. It should not be plugged in if there is water on parts that are not intended to be wet.

C. Do not operate the heater if it has a damaged cord or plug, is malfunctioning, dropped, or damaged in any manner. The power cord of this heater cannot be replaced. If the cord is damaged, the heater should be discarded.

D. To avoid the possibility of the heater plug getting wet, position the aquarium and its stand to one side of a wall mounted outlet to prevent water from dripping onto the outlet or plug. A “drip loop”, shown in the figure below, should be arranged by the user for each cord, which connects the heater to the outlet. If an extension cord is used, the “drip loop” is the part of the cord below the level of the outlet or the connector that prevents water from traveling along the cord and coming in contact with the outlet. If the plug or outlet does get wet, **DO NOT** unplug the cord. Disconnect the fuse to the circuit breaker that supplies power to the heater. Then, unplug and examine for the presence of water in the outlet. If you are not sure, consult a certified electrician.

POWER CORD

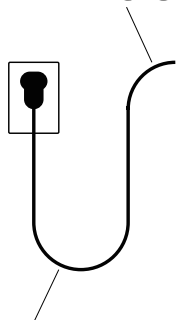

DRIP LOOP

3. Close supervision is necessary when the heater is used near children.
4. This heater is not allowed to use by persons (including children) with reduced physical sensory or mental capabilities, or lack of experience and knowledge unless they have been given supervision or instruction concerning the use of the heater by a person responsible for their safety.
5. To avoid injury, do not contact moving or hot parts.
6. Always unplug the heater from the outlet when not in use, before putting on or taking off parts, maintenance, or placing hands in the water. Never yank the cord to pull the plug from the outlet. Grasp the plug and pull to disconnect.
7. Do not use the heater for other than intended use. The use of attachments not recommended or sold by the appliance manufacturer may cause an unsafe condition and will void the warranty.
8. Do not install or store the heater where it will be exposed to extreme weather or temperatures below freezing.
9. Only use the heater in freshwater or saltwater, do not use it in other liquids.
10. Make sure the heater is securely installed before operating it.
11. Read and observe all the important notices on the heater.
12. If an extension cord is necessary, a cord with a proper rating should be used, such as rated amperes or watts. A cord rated for fewer amperes or watts than the heater rating may overheat. Care should be taken to arrange the cord so that it will not be tripped over or pulled.
13. The heater is intended FOR HOUSEHOLD USE ONLY.
14. SAVE THIS USER MANUAL.

7. ATTENTIONS

- √ Please check all the items to inspect their condition when unboxing the package.
- √ Please read this user manual carefully before using and follow it strictly.
- √ Please choose a heater rated for your aquarium.
- √ Please place the heating rod in the way of water flow and don't bury it in the substrate.
- √ It is suggested that the heater is submerged more than 5 inches below the water.
- √ Please make sure the heating rod is fully submerged when it's on duty. Unplug the heater and wait for 15 minutes before changing the water or removing the heater.
- √ Please mind that the heater can be turned off automatically when exposed to air, but it is a last resort and should be avoided.
- √ After using the heater for a while, calcium carbonate contained in algae or moss may clump and adhere to the heating rod.
- √ If dirt adheres to the heating rod, use a sponge or cloth and water to wipe it. Do not use alcohol or other chemicals as this may damage the heater and harm the fish or other livestock.
- √ If you use the heater for a prolonged period with dirt adhered to the heating element, please be aware that failure may occur due to the inability to control the temperature correctly.
- √ Please place the heating rod far away from the magnetic brush since the magnet will possibly damage the heating element.

√ There will be a little mist on the inner wall of the tube while heating, and it will disappear slowly after the heating stops, which means it's a normal phenomenon. So you don't have to worry about it, it is a safe and double-protected product that has passed the UL certification.

8. HYGGER LIMITED MANUFACTURER'S WARRANTY

We offer the end user of this product a manufacturer warranty of 3 (2) years from the date of sale if this product was purchased from a hygger[®]-authorised specialist dealer.

Retain receipt for any future warranty claim. Conditions apply. Products are guaranteed by hygger[®] Aquatic Supplies to the original purchaser against defective material and workmanship under normal use for a period up to 3 (2) years from the date of the original purchase through an Authorized Dealer. Refer to the User Manual included with your product for specific warranty details.

Products have no warranty if:

- 1.) The product has been serviced, modified or tampered with by anyone other than hygger[®] Aquatic Supplies.
- 2.) The product has been abused or damaged (including broken or cracked bulbs), and/ or.
- 3.) The product has been transported without proper packaging.
- 4.) The product was purchased from an Unauthorized Reseller.

WARRANTY LIABILITY DISCLAIMER

In no event will hygger[®] be liable for any consequential or incidental damages, including but not limited to, lost aquatic life, personal injury, property damage, equipment damage, lost profits, lost wages, lost savings, lost income, etc., arising out of the use of any hygger[®] products.

- 1.0. Terms and Conditions of Warranty.
- 1.1. hygger[®] warrants to the purchaser, for 3 (2) years from date of original purchase through an Authorized hygger[®] Reseller, free to repair or replace parts where fault is found due to defective materials or faulty workmanship and where goods do not operate in accordance with the instructions.
- 1.2. All claims for repair or replacement must be made at place of purchase.
- 1.3. Only the direct purchaser is entitled to warranty claims against us and these are not transferable without our consent.
- 1.4. The original and dated Proof of Purchase (receipt) must be supplied with all goods claims. Please also provide this Guarantee where possible.
- 1.5. Wear parts (e.g.: seals, suction devices, axes, pump wheels, light sources, pH electrodes, filter media, such as filter cartridges, as well as UVC burners), glass damage and the opening of the product, as well as structural changes or the use of non-hygger[®] original parts are excluded from the guarantee.
- 1.6. All goods subject to claim under Guarantee should be prepared for transportation in the original packaging or other comparable packaging which offers the same degree of protection and hygger[®] must incur no costs from the shipment.
- 1.7. Where claims on inspection reveal goods are in normal working order, hygger[®] will request reimbursement of all reasonable costs incurred.
- 1.8. Warranty claims do not exist in the case of only insignificant deviations from the agreed or customary condition or usability, e.g. insignificant deviations in colour, dimensions and/or quality or performance characteristics of the products.

1.9. Our warranty obligation extends only to the delivery of newly manufactured products. Unless otherwise agreed, used products are sold as seen, excluding any warranty.

For more warranty information, please see the hygger website.

9. DISPOSAL

Do not dispose of this product as unsorted municipal waste. Collection of such waste separately for special treatment is necessary. This product has to be disposed of at an authorized place for the recycling of electrical and electronic appliances rather than being disposed of together with the domestic waste. Collecting and recycling waste is a way of saving natural resources. So, please consult with your local seller to make sure the product is disposed of in an environmentally friendly way.

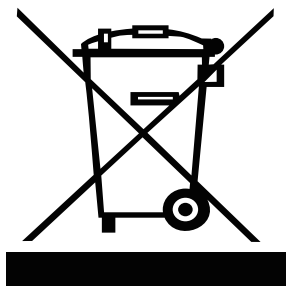

10. PACKING LIST

1x hygger Wire Drawing Aquarium Heater and Controller
4x Suction Cup (for securing the heater in the tank)
1x User Manual

11. CONTACT INFORMATION

Distributed by:Hygger Aquarium, Inc.
13941 Magnolia Ave, Chino, CA 91710

E-mail: distributor@hyggeraquarium.com
Website: www.hyggeraquarium.com

Trademarks of Shenzhen Mago Trading Co.,Ltd
Bantian Group Business Center,Longgang,
Shenzhen City, China
All Rights Reserved

Made in China



Have a question? We're here to help:
USA Call: +1 (909) 590-2880
Mon-Fri: 9:00 am - 5:30 pm PST
Sat-Sun: Closed

EC	REP
-----------	------------

E-CrossStu GmbH
Mainzer Landstr.69, Frankfurt am Main,
Baden-Württemberg, 60329, Germany
E-CrossStu@web.de
+49 69332967674

UK	REP
-----------	------------

YH Consulting Limited
C/O YH Consulting Limited Office
147, Centurion House, London Road,
Staines-upon-Thames, Surrey,
TW18 4AX, London
H2YHUK@gmail.com
+44 07514-677868



MADE IN CHINA